

AVANT[®] magazine

Avant Tecno customer magazine 2022



New Avant 645i and 650i

p. 4

Avant Power to the forefront of battery technology [p. 10](#)

Leguan reaches new heights [p. 13](#)

LEGUAN®

leguanlifts.com



REACH
THE
NEXT
LEVEL

225

Meet the Leguan 225

Get ready for the next generation of spider lifts. With faster boom hydraulics, greater working height, unrivaled up-and-over reach, and ground-breaking joystick controls, the Leguan 225 is our most advanced spider lift to date. User-friendly design, improved driving features and a steel-reinforced chassis guarantee premium performance even in the roughest terrains.

PART OF
AVANT
GROUP

Editorial

Another year full of surprises

As fall slowly turns to winter and we assess the current year, we can easily say that it has been full of surprises, much like the few years preceding it. The war in Ukraine has had several effects on our factory, such as component availability problems and rising prices. All in all, these past years have been challenging for manufacturing and purchasing. I must say we have gotten through these difficult times well. We have managed to grow our company with more than 20% per year in the last three years in a row. There have, of course, been delivery issues, but we are working very hard to solve them all. We have faith in the future, and we plan to grow also in the following years.

One big highlight of this year was the public debut of our fourth overseas sales company in Brazil last spring. Meanwhile in the USA, our sales company celebrated its 10th anniversary. During the past decade, Avant has significantly changed the US market (see story on pages 18–19), and Avant Tecno USA sets an important example to Avant Tecno do Brasil (pages 26–27). We are very excited to learn more about the Brazilian market and we expect it to be an important market for us in the future.

Another big highlight of this year is the Bauma fair in Munich. Held every three years, the world's largest construction exhibition attracts more than 600,000 visitors. In Avant's early days – the beginning of the 1990s – it was pivotal to our success. In the 1992 exhibition, we got many importers who are still our dealers. Today, as we are represented on all continents, our focus is on showing our new innovations in the field of compact loaders and attachments. In Bauma 2022, we are launching many new products and a totally new company destined to develop and manufacture lithium-ion batteries. You can read more about the new products on pages 4–13 in this magazine. We are very excited to present them to the public, as we have been working on them for quite a while.

Hope you enjoy the Magazine, and if you intend to visit Bauma, make sure to visit us there.

Jani Käkälä
CEO, Avant Tecno Oy

Avant Tecno Customer Magazine 2022

Editor-in-chief: Saara Pakarinen,
Avant Tecno Oy
Publisher: Avant Tecno Oy
Layout: Tulus Oy
Print: Offset Ulonen Oy, Tampere, Finland
Edition: 2 000

AVANT

Ylötie 1, 33470 Ylöjärvi, Finland
P. +358 3 347 8800
E-mail: sales@avanttecno.com

Contents

The new Avant 645i and 650i models	4
Avant Power leaps to the forefront of innovative battery technology	10
Leguan reaches for the next level	13
New attachments	14
Ten-year-old Avant Tecno USA is proceeding at breakneck speeds	18
Brazil, here we come!	20
On track at Superbloom	22
“We cannot imagine our work without our green friend”	24
Keeping Boston beautiful	26
Easier work at French camp sites	28
Adding a kick to landscaping in Australia	30

Superbloom, p. 22.



The new Avant 645i and

Raw power in a tight package

Our brand new 600 series models are the most powerful loaders in their size class in the world. These compact, quiet, low-emission loaders bring unsurpassed comfort to the working day with the new GT cab.



650i models



The light machine is gentle on the turf and other delicate working surfaces. It is also easy to transport from one job site to another.



The new Avant 645i and 650i models are the world's most compact loaders in their power class which are equipped with a diesel particulate filter, thus meeting the EU's strict Stage V emission regulations and Tier 4 Final regulations in the USA. The machines come into their own in demanding professional use and in cramped workspaces.

In April of this year, we launched our long-awaited 600 series models, the Avant 645i and 650i. The dimensions and lifting power of the new machines are in the same range with the previous 600 series models, but the engine is now new. Kubota's 33 kW / 44 hp diesel engine provides plenty of power and torque for work which requires high pulling force and/or is speed intensive.

"We are very satisfied with the new loaders. The greatest thing is that we packed the power of the 700 series into the frame of the 600 series. Now there is plenty of power in a very compact machine, so you can drive big snow blowers and crushers without any problems. No other manufacturer offers this much power in such a small package," says *Olli*

Hankamäki, who was responsible for the design.

The single-speed Avant 645i is particularly suitable for tight and limited work spaces, whereas the two-speed 650i model is the right choice when working in a wider area and the highest possible driving speed is needed.

Inspired by emission requirements

The development of the new machine models was sparked by the EU's strict Stage V emission standard. The current EU Stage V emission standard for diesel engines in non-road mobile machinery requires a catalytic converter and a particulate filter for engines above 19 kW.

"When the emissions regulation came into effect in 2019,

it forced us to reduce the power in the 600 series, which was reflected in the performance of the machines. But now, thanks to the new engine, the power of these models matches the power of the 745 and 750 models. The new loaders comply with both European Stage V and US Tier 4 Final emission standards,” says design engineer *Juho Jokelainen*.

The single speed 645i and the two-speed 650i are both equipped with a Kubota V1505CRT diesel engine. The 4-cylinder turbocharged common rail engine has an oxidation catalyst and particulate filter which handle the exhaust aftertreatment, and no additives (AdBlue) are required.

The particulate emissions of loaders equipped with a filter are equivalent to a modern passenger car engine. The Avant user notices the cleanliness in their work: there is no need to suffer from smoke or odors on the construction site.

Since the engine is very efficient, it does not need to be used at full power, if not necessary. Fuel consumption is minimal compared with large work machines.

Modern engine control adjusts the combustion according to the prevailing conditions, which reduces fuel consumption and minimizes emissions. The engine also reacts faster to load variations and the driver’s requests, which makes using the machine more efficient and smoother.

Efficient and quiet working

The maximum oil flow of the auxiliary hydraulics is 75 l / min, which is unique to a loader in this size class. The new loaders can run almost any of Avant’s hydraulically driven attachments at full speed.

The powerful engine is quiet in use because it can be used at low revs.

“We have been able to reduce the noise level in this size class lower than ever,” says Olli Hankamäki.

In official measurements, the sound power level was LWA 98 dB (A), when the machine was stressed at full speed. The sound pressure level in the driver’s seat was 83 dB (Lpa).

“These loaders are the quietest Avants right after the fully electric e-series machines,” says Olli.

Unsurpassed comfort

An open ROPS/FOPS-certified cab is standard equipment on the new machines. Available as an option are the L-cab and Avant’s latest GT cab, which brings completely unique comfort to this size class. The sound and vibration insulation of the spacious and modern GT cab is very good,



—
More power,
more torque,
more Avant!



Other loader manufacturers do not have nearly as efficient a machine in the corresponding size category.

and the cab's efficient heating, good ergonomics and large windows make the operating experience very pleasant. Air conditioning is also available for the GT cab.

“On the seat of the GT cab, you feel like you're driving a bigger machine, even though you have a very agile loader underneath you, which can also fit into places that you couldn't reach with big machines,” says Olli Hankamäki.

More data for the user

The user interface and display in these loaders are similar to Avant's 700 and 800 series loaders.

“The user gets even more information about the state of the machine. In the event of malfunction or maintenance, the machine tells you that now is the time for maintenance. The system also shows error codes to the user,” says Juho Jokelainen.

This way the user can see for themselves what is wrong. When calling for service, they can report the fault code, which facilitates the investigation of the fault. The system also helps an alert user to identify emerging problems. ●

The best aspects of the new machine models are silence, cleanliness, strength, and economy. Pictured below, the Avant 645i with a Power Rake.





MODEL	AVANT 645i	AVANT 650i
Length	2 610 mm	2 610 mm
Width (STD wheels)	1 290 mm	1 290 mm
Height	2 060 mm	2 060 mm
Weight	1 620 kg	1 630 kg
Pulling force, max.	1 400 kp	1 400 kp
Drive speed, max.		
26x12.00-12" STD wheels	12 km/h	23 km/h
320/55-15" wheels	13 km/h	25 km/h
Auxiliary hydraulics	75 l/min 200 bar	75 l/min 200 bar
Lift height, max.	2 835 mm	2 835 mm
Tipping load	1 190 kg	1 190 kg
Engine make and type	Kubota V1505-CR-TE5 Stage V / Tier 4 Final 4-cylinder	Kubota V1505-CR-TE5 Stage V / Tier 4 Final 4-cylinder
Engine output (ECE R120)	33 kW / 44 hp	33 kW / 44 hp

You can find more information about our option range on our website www.avanttecono.com or by contacting your local Avant sales. Watch the machine launch event as a recording (More Avant - 645i & 650i launch event) on our YouTube channel [@avanttecono](https://www.youtube.com/@avanttecono).

Production of the new machine models started in fall 2022.



AVANT POWER leaps to the forefront of innovative battery technology

Avant launches two new electric loader models in Bauma 2022

The capacity of electric loaders enters a whole new level as Avant's new subsidiary, Avant Power, starts producing battery packs for fully electric Avants in 2023. Two new fully electric loader models, the Avant e527 and Avant e513, will be equipped with Avant OptiTemp batteries (27kWh and 13kWh) which feature a globally unique thermal management system. With a fully charged battery in the Avant e527, you can in most cases work the whole day with one single charge, the battery capacity being twice the size of other manufacturers' products.

“We have been doing research and development related to electric loaders since the 1990s, and our first fully electric loader was introduced in 1997. After working with electric loaders and batteries for decades, we realized that there was no battery pack in the world that would be perfectly optimized for compact loaders. That's why we decided to start making such products ourselves,” says *Mikko Piepponen*, Chief Operating Officer at Avant Power Oy.

As a team of engineers started designing these new generation batteries in-house, the target was set high: the new batteries had to be 100% safe, their capacity had to be high and the production costs low. Since Avants are sold in all parts of the world, the batteries needed to be suitable for all

“An innovative thermal management system makes the new Avant OptiTemp batteries completely unique on a global scale,” says Mikko Piepponen, COO of Avant Power and the mastermind behind the new technology.

markets. Not an easy task, one might say, but the team loves challenges.

“Creating solutions that seem impossible at first is what gets us going,” says Piepponen.

After years of intense work, Avant Power is now launching two new OptiTemp battery packs. These batteries will be used in Avant e527 and Avant e513, bringing efficiency and safety of electric loaders to the next level.

Temperature always in control

The new OptiTemp battery packs feature a globally unique immersion lithium-ion technology offering Avant users several benefits.

Thanks to the great power-to-volume ratio of the new batteries, it is now possible to work with an electric loader more efficiently than ever.

Avant OptiTemp batteries bring the capacity of electric loaders to the next level. Work all day with one charge!

As the name of the batteries implies, a unique thermal management system, OptiTemp, keeps the temperature optimized when the loader is used or plugged into a charger. In the batteries' submersible structure, all the cells are surrounded by a special liquid. The immersion cooling system controls the temperature and lets you work just as efficiently in the summer and winter. In cold weather conditions, the battery automatically pre-heats itself before use, and during operation of the loader, the temperature management system maintains the operating temperature.

“Many battery manufactures tend to forget cold working conditions, but Avant OptiTemp batteries work very well in freezing conditions – all the way down to -30°C/-22°F, when preconditioned,” Piepponen says.

“The cooperation with Avant Power, and the batteries they have developed, allow us to build the kind of electric loaders that the market has been longing for. Longer working time and more affordable pricing have been key issues with electric loaders until now. With the new e5 models, we intend to tackle them both,” says Jani Käkälä, CEO of Avant Tecno.

The OptiTemp system also makes the batteries extremely safe. The specially designed liquid inside the battery modules controls heat transfer from one cell to another. As the cells won't be overheated, the batteries are extremely safe to use. Another safety solution is the multi-level protection system. All cells inside the battery are protected by fuses and isolated from each other on several different levels.

“The world of battery technology is still quite wild regarding safety regulations. For us, safety is an absolute priority. We make batteries which guarantee zero incidents,” Piepponen says.

Avant users looking to acquire a new fully electric Avant e513 or Avant e527 can expect a longer operation time, getting heavier work done, faster charging, longer battery life, working in extreme weather conditions and absolute safety. All this comes with affordable pricing yet unseen in the market. Production of the batteries starts in the first quarter of 2023.



A short history of electric Avants

Electric Avant 1.0

Avant introduced the first fully electric loader in 1997. Technically the machine worked well, but effective operation time was only 1–2 hours. Therefore, the loader was suitable only for very few specific jobs. Since global demand was somewhat low back then, the project was put on hold. However, our faith in the future of electric machines didn't waver and we kept this possibility in mind.

Electric Avant 2.0

Development was restarted. The basic structure of the Avant loader was modified and optimized for an electric model. The next generation electric Avant was introduced in 2017.

Development had taken quite a leap; the capacity of the lithium-ion battery was three times bigger than in the first Avant e-series. This was already sufficient for quite versatile work, but it was clear that an even greater capacity of the battery would improve and expand the usability of the loader significantly.

Electric Avant 3.0

In this phase, Avant took the reins in developing batteries. Due to a successful product development project, Avant is now introducing an entirely new Avant battery series. This power source optimized for loaders clearly beats competitors on many important levels.

CHARGING

The e5 series has three charging options. The loader has a built-in onboard charger which allows you to charge with any 220V outlet. The onboard charger is intended mainly for overnight charging.

The 400V rapid charging stations (16A and 32A versions) are available as an option. The station is easy to move from jobsite to another because it has the Avant quick attach. Rapid charging is intended for charging during the workday.

Charging times:





Loader model	Avant e513	Avant e527
Onboard charger	5 h	10 h
Rapid charger 400V/16A	1 h 30 min	2 h 45 min
Rapid charger 400V/32A	-	1 h 30 min

Avant e513 & Avant e527 in a nutshell

Loader model	Avant e513	Avant e527
Voltage	44V	44V
Capacity	13 kWh	27 kWh
Operation time*	3 hours	6 hours
Lift capacity	900 kg	900 kg
Lift height	2 790 mm	2 790 mm
Drive speed	10 km/h	10 km/h
Auxiliary hydraulics	30 l/min	30 l/min

*In medium duty loading work; no hydraulic attachments used.

The benefits of Avant OptiTemp batteries

-  **High capacity: up to 27 kWh.** The Avant e527 has twice the capacity of other loaders in its size class. You can work the whole day with one single charge.
-  **OptiTemp system inside.** The innovative thermal management system keeps the temperature optimized and gives you the same capacity in hot and freezing weather. The key benefit of the OptiTemp battery is that it works very well even in very cold conditions (-30°C/-22°F), when preconditioned. As the battery is plugged into a charger, the temperature control system is automatically switched on. When the workday starts and the loader is unplugged, the battery temperature is already optimized for hard work – adjusted to the prevailing weather conditions.
-  **Rapid charging stations available.** Thanks to the structure of the battery, you can charge your battery in just 1,5 hours with a rapid charger, which enables long workdays.
-  **Absolute safety.** No other battery manufacturer in the world has similar solutions for safety. In Avant OptiTemp batteries, there is no risk of propagation – meaning thermal runaway from one cell to another – or flame leakage outside the battery device. Absolute safety is guaranteed by the structure and the immersion cooling system of the battery. ●

Leguan reaches for the next level

Leguan Lifts unveils their largest spider lift to date, Leguan 225, specially designed for outdoor work and challenging terrains.

First presented at the Bauma fair 2022, The new Leguan 225 features faster boom hydraulics and a higher working height compared to previous models. The new and unrivaled up-and-over and side reach is designed to especially match the demands of the tree care market. In addition to the enormous working envelope, all the hydraulic hoses and components are protected inside the new boom construction, and the chassis is steel reinforced to enable work in even the roughest terrains.

Leguan spider lifts are known for their efficient performance in slopes and uneven work sites thanks to their advanced track design and low center of gravity, and in this aspect, the new Leguan 225 is no different from its predecessors. But to take the new model to the next level, Leguan's product developers have focused on improving the driving features allowing more powerful turning even when driving at fast speeds and a smoother riding experience when operating the spider lift from the basket.

The new Leguan 225 will be the most user-friendly spider lift in its class thanks to its intuitive joystick control and modern features such as back-to-home and back-to-work functions. Together with the lauded Leguan service display that ensures premium customer satisfaction and easy after sales support, this model is the next chapter in the success story of Leguan spider lifts.

The new Leguan 225 can be towed with the special-made 3,5-ton Leguan trailer that will be available in the European market. ●

Leguan 225 – key features

- Faster boom hydraulics
- Higher working height
- Unrivaled up-and-over and side reach
- Intuitive joystick control
- Improved driving features

With a track platform designed for rough and challenging terrains, the Leguan 225 is at home in gardens, parks, forests, and construction sites. The boom is shielded from external blows, falling branches and sawdust, making the 225 a great choice for arborists and construction workers alike.

NEW ATTACHMENTS

Compatibility

✔ Very compatible
 + Compatible
 ✘ Incompatible

Mini digger 180

Mini digger 180 features hydraulic boom swing: the boom can be turned 60° to the right or to the left from centerline. This makes the mini digger even more versatile than before:

- By turning the boom to the side the bucket can be emptied without the need of moving and articulating the loader
- The optional tilt adapter makes it possible to dig with the bucket in many different angles, and it is also possible to dig alongside the wall with the boom turned to the side and bucket tilted parallel to the wall

Mini digger 180 is equipped with the same S30 bucket quick attach system as mini digger 150 and backhoe 260, which makes changing of bucket fast and easy - and the bucket can also be mounted pointing forward if necessary. Bucket tilt adapter or hydraulic thumb grab are available as an option. Both cannot be mounted on the mini digger simultaneously.

Because there are two hydraulic functions on the mini digger as standard – boom swing and bucket operation – there is also an electric selector valve for selecting the function. Boom swing and bucket cannot be operated at the same time. The selector valve is controlled with the switches on the optional Opticontrol® control switch pack which is necessary on the loader.

- Efficient and handy digging unit, very fast and easy to mount on the loader
- Hydraulic boom swing, ± 60° to the side from centerline
- Max. digging depth 1800 mm
- Digging alongside wall possible with the optional bucket tilt adapter

Model	180
Max. digging depth	1 800 mm
Boom swing angle	±60°
Weight (without bucket)	170 kg
Product no. (without bucket)	A445112

OPTIONS:

- Bucket tilt adapter A446187 (not when thumb grab A446167)
- Thumb grab A446167 (not when bucket tilt adapter A446187)



Buckets available

250 mm	A414301
400 mm	A414304
750 mm	A35230
1000 mm	A35383
Trapezoidal bucket 650 mm	A21638
Trapezoidal bucket 912 mm	A36374

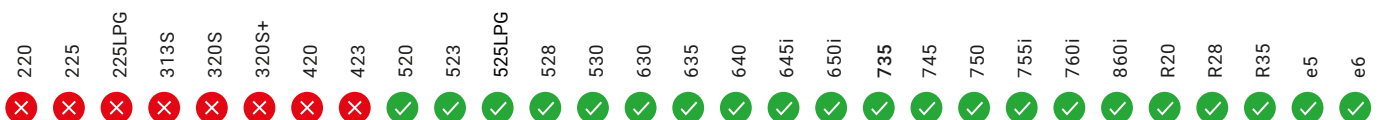

Sleeves on pallet forks

There are two types of sleeves available for 1100 mm and 1200 mm long pallet forks. They are pushed on the fork and locked with a bolt.

Nursery sleeves are intended especially for handling larger plants with root balls. The plants stay better on the sleeves than on the forks only, and the risk of damaging the root ball is smaller. The sleeves can be mounted both on the standard 1100 mm and 1200 mm pallet forks and the hydraulic forks, but it is much easier and faster to handle different size plants with the hydraulically adjustable forks.

Bale sleeves allow lifting and handling different (round) bales. They work best on the A442071 HD hydraulic pallet forks.

	Nursery sleeves	Bale sleeves
Length	1 356 mm	1 325 mm
Weight	57 kg	27 kg
Product no	A444929	A448768

Compatibility:
pallet forks A21039,
A36589, A36279,
A449516, A442071



220	225	225LPG	313S	320S	320S+	420	423	520	523	525LPG	528	530	630	635	640	645i	650i	735	745	750	755i	760i	860i	R20	R28	R35	e5	e6		
✓	✓	✓	✓	✓	✓	✓	✓	✓	✓	✓	✓	✓	✓	✓	✓	✓	✓	✓	✓	✓	✓	✓	✓	✓	✓	✓	✓	✓	✓	✓

Pallet fork with side shift

Hydraulic fork adjustment on the pallet fork makes it possible to move the forks further apart or closer to each other easily and comfortably from the driver's seat. The forks can also be moved to the left or to the right, making it possible to shift the load to the side of the machine – closer to a wall for example.

All functions can be operated from the driver's seat. Pallet fork is equipped as standard with a bolt-on back frame which allows handling of larger loads and protects the driver from falling objects.



The optional Opticontrol® is recommended on the loader.

- Hydraulic side shift and fork width adjustment
- Bolt-on back frame as standard
- Two models available, with 1100 mm or 1200 mm forks, max. load 2000 kg on both

	Standard	XL
Fork length	1 100 mm	1 200 mm
Max. load	2 000 kg	2 000 kg
Frame width	1 105 mm	1 550 mm
Weight	190 kg	225 kg
Product no	A449516	A442071

Std.	✗	✗	✗	✗	✗	✗	✗	✗	✗	✓	✓	✓	✓	✓	✓	✓	✓	✓	✓	✓	✓	✓	✓	✓	✓	✓	✓	✓	✓
XL	✗	✗	✗	✗	✗	✗	✗	✗	✗	+	+	+	+	+	+	+	+	+	+	+	+	+	+	+	+	+	+	+	+

NEW ATTACHMENTS

Compatibility



Very compatible



Compatible



Incompatible

Seeding machine

Seeding machine is a professional mechanical surface seeding unit, intended for precise seeding of lawns, different types of (flower) meadows, pastures etc. The rotating feeding roller with 12 nozzles provides accurate and reliable seed sowing, and the seed amount adjustment range is very wide, approx. 50 - 3000 g/100 m².

It is possible and advisable to make a seeding test before starting operation, in order to make sure that a right amount of seed goes to the ground. The seeding machine is equipped with 4.00-8 tractor profile tyres and a manually operated support leg.

Rear harrow and rear field roller are available as an option, for finishing and compacting the surface. The seeding machine can be mounted either on the attachment coupling plate of the loader – in this case seeding happens by reversing with the loader – or it can be towed by mounting the optional Avant drawbar A37481 on the unit. In this case the loader must be equipped with the trailer ball hitch.



OPTIONS:

- Rear harrow A450437
- Rear field roller A450438
- Drawbar A37481

- Efficient and professional attachment for seeding of lawns, meadows, pastures etc.
- Precise and widely adjustable seed feeding through 12 nozzles
- Seeding test can be performed before starting operation
- Can be mounted on the attachment coupling plate of the loader or towed with the optional Avant drawbar

Working width	1 500 mm
Total width	1 890 mm
Length	890 mm
Height	1 070 mm
Seed box volume	45 l
Seed amount adjustment	approx. 50 - 3 000 g / 100 m ²
Weight	135 kg
Product no	A449473

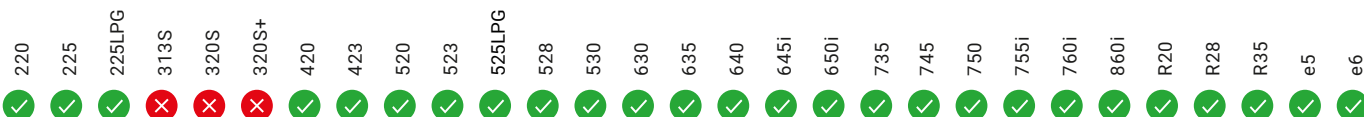

Side shift arm 1200

The rigid side shift arm is a side shift adapter which places the attachment 1200 mm to the side from the centerline of the loader's attachment coupling plate. There are quick attach brackets at each end of the arm, which means the attachment can be either on the right or on the left side of the loader. Max. load on the arm is 500 kg. It allows, for instance, mowing on the side of the loader with the flail mower, cutting bar etc.

The side arm is equipped with a manually operated support leg and a 1200 mm long hydraulic hose kit (3 hoses) in case the attachment's standard hoses are not long enough to reach the multi connector on the auxiliary hydraulics outlet of the loader.

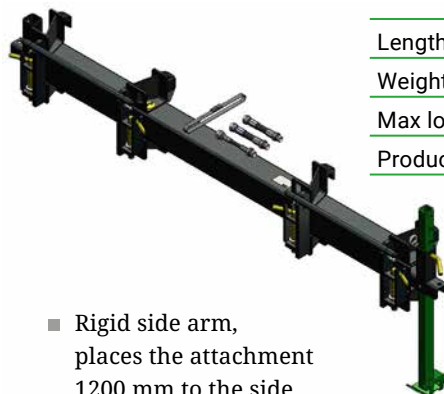

Length	1 962 mm
Weight	60 kg
Max load	500 kg
Product no	A449089

- Rigid side arm, places the attachment 1200 mm to the side
- Allows, for instance, mowing on the side of the loader with flail mower, cutting bar etc.
- Quick attach brackets at each end – attachment can be on the right or on the left side of the loader

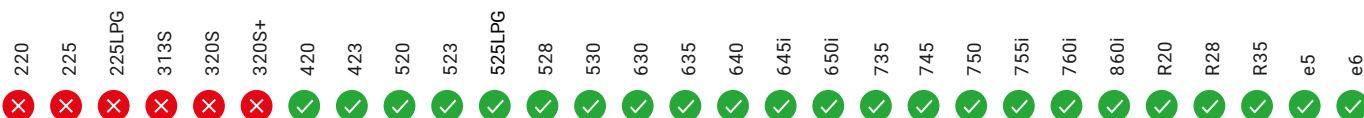

Snow plow V1600

Avant snow plow is a versatile attachment for snow removal. It consists of two independently hydraulically controllable blades which can be adjusted in straight, V or Y position. This means snow can be moved to one side or to both sides of the loader or collected with the blades in Y position. Both blades have a spring release mechanism in the lower part of the blade to prevent any sudden stop should the blade hit an obstacle. The floating mechanism on the mounting bracket guarantees that the plow follows ground as well as possible.

Three working widths available, for smaller and larger areas. The newest V1600 model is especially destined for efficient snow removal on narrower sidewalks, paths, parking lots etc.

The optional Opticontrol® is required on the loader if blades are wanted to be controlled independently (requires also 6 or 8 function joystick on the loader).

	V1600
Blade width	1310-1600 mm
Total width (with curved end flat cutting edge/ice scraper edge)	1370-1660 mm
Blade height	736 mm
Blade turning angle	+/- 35°
Weight	210 kg
Product no.	A451470



- 220
- 225
- 225LPG
- 313S
- 320S
- 320S+
- 420
- 423
- 520
- 523
- 525LPG
- 528
- 530
- 630
- 635
- 640
- 645i
- 650i
- 735
- 745
- 750
- 755i
- 760i
- 860i
- R20
- R28
- R35
- e5
- e6

Multi-purpose grapple

The HD timber grabs which mount directly on the attachment coupling plate of the loader, product nos. A436473 and A437203, will change to a new type of multi-purpose grapple towards the end of 2022. The product numbers of the grabs will not change.

This new HD multi-purpose grapple can pick up logs, branches, pipes etc. as well, but thanks to the sharp-edged claws it is also suited, for instance, for removing small tree stumps, rocks, roots, bushes, and similar unwanted vegetation from the ground. Grapple opening is max. 1340 mm.



- 220
- 225
- 225LPG
- 313S
- 320S
- 320S+
- 420
- 423
- 520
- 523
- 525LPG
- 528
- 530
- 630
- 635
- 640
- 645i
- 650i
- 735
- 745
- 750
- 755i
- 760i
- 860i
- R20
- R28
- R35
- e5
- e6



Ten-year-old **Avant Tecno USA** is growing at breakneck speeds

Avant loaders are conquering the American continent at an accelerating pace. A decade ago, the USA didn't know what an Avant was, but now competitors have started imitating the small but mighty Nordic machine. Today, our sales company in the USA employs 26 professionals, and the annual growth is up to 30 percent.



Avant's growth in the USA has been astronomical, especially during the last five years. The local sales company in Chicago now sees approximately 30 percent growth year-over-year.

Having been appointed President of Avant Tecno USA in July of 2021, *Beau Slavens* oversees sales and distribution for Avant in the United States and Canada.

"I took this role because I was so excited about the growth potential and uniqueness of the Avant product," says Slavens, an experienced third-generation professional in construction equipment sales.

According to Slavens, Avant stands out strongly on the market due to quality, the service and support the equipment gets, and the genuine multi-purpose nature of the machines. Success has also been accelerated by the efficient 800 series, the fully electric machines, and Leguan Lifts. Avant's equipment

covers tree care, construction, property maintenance – almost any job.

“There aren’t many other manufacturers out there who can say that.”

In the beginning, the biggest hurdle for Avant USA was that the market was very skid-steer driven.

“Everyone seemed to have a skid steer for all applications and jobs. Avant was a foreign concept and people were confused by it. But now, we’re becoming a well-respected brand in the industry. The big players are now manufacturing compact loaders because they see the kind of buzz and brand loyalty we’re earning in this space,” Slavens says.

Top brand of the future

Avant Tecno USA intends to continue its rapid upward trajectory.

“We are incredibly proud to have more than 170 dealer locations across the United States and Canada,” says Beau Slavens.

Expanding the dealer base and establishing long-term partnerships have formed an important cornerstone for success. Customers have also noticed the strong motivation of the staff, which is directly reflected in the sales figures. More and more Avant users return later to buy a new machine.

Slavens praises the strong international cooperation at Avant.

“The support we get from Finland is unlike anything I’ve ever seen or experienced from a corporate office. We have a direct line to the factory for support and ideas. Our product specialists and sales managers are out in the field talking to customers every day, and it’s not uncommon for them to call or send an email to engineers in Finland. And the next thing you know, we have a prototype to test out in the field.”

The USA is a geographically large market, where the



“We are incredibly proud to have more than 170 dealer locations across the United States and Canada.”

Beau Slavens, President

environmental conditions and needs for machines vary. The focus has always been on the value Avant delivers to customers and users on sites that may be very different from each other. And we haven’t seen it all just yet. When asked if he believes Avant will become a household name in the United States during his tenure with Avant, Slavens doesn’t skip a beat.

“Absolutely – we’re on track to get to that place where people know the name and they’re excited about the product. I can’t wait to do my part in getting us there.” ●

Avant Tecno USA’s staff is very entrepreneurial, according to President Beau Slavens (second right). “Everyone knows their job and takes full responsibility for their job – our corporate culture is very much guided by teamwork, innovation, and integrity.”



Brazil, here we come!

Avant established a sales company in Brazil in 2019. The first three years were spent dealing with the country's strict bureaucratic hurdles, but last spring, Avant made its public debut at the gigantic agricultural fair Agrishow. Local interest is strong, says Jere Pitkänen, Managing Director of the sales company.

After years of groundwork, our latest foreign sales company Avant Tecno do Brasil made its public debut in Brazil at the local Agrishow fair in April. Participating in the huge agricultural trade fair was a success for Avant.

"At Agrishow, we presented all our machinery and different types of attachments. We were very well received," says *Jere Pitkänen*, Managing Director of the sales company.

Jere has lived in Brazil since he was 12, and he took up his post at Avant in March. According to Jere, Avant's green color is now attracting interest from all passers-by and the

feedback from the trade has been very good.

"Construction and demolition professionals have praised the machine's operating costs as we have compared Avant with skid steer loaders. The feedback from local farmers and machine dealers has also been very positive," says Jere.

"Farmers have difficulties finding labor for their farms. The new generation of family farm managers is of the opinion that a compact machine that does many different jobs is what will save them. Machinery dealers and dealers in other brands are also interested in Avant. They believe that the market for small loaders in Brazil will grow strongly in the coming years."

We now have our own sales company and two dealers in Brazil. After the trade fair, more interested parties joined the queue.

Threshold of bureaucracy

Opening the door to the Brazilian market is difficult for foreign operators. *Matti Aalto*, the former CEO of the sales company, who spent three years laying the groundwork for the launch, knows this.

A MARKET OF OPPORTUNITIES

On the map, Brazil is as big as the whole of Europe and its waters. The country is very rich in agriculture, food, oil, mining, and automotive industries. Brazil is also home to all of Avant's potential user segments.

"The size and potential of the market require a lot of investments from Avant, but with hard work, we can build an organization that can meet the demand. We at Avant are not afraid of challenges," says *Jukka Vaattovaara*, Sales Manager, who visited Brazil and the Agrishow fair last April.



Jere Pitkänen (right), the new CEO of Avant Tecno do Brasil, started his new job with full energy. Jere's predecessor Matti Aalto will continue in a consulting role before retiring.

“The difficulties stem from Brazil’s protectionism. The country is one of the most bureaucratic in the world, and there are many barriers to imports, such as tax and customs barriers. Everything took time – from opening a bank account to obtaining unlimited import rights.”

Brazil is not yet part of the modern world’s VAT system, despite decades of talk of a tax reform. Fortunately, the EU–Mercosur Free Trade Agreement, which will make it easier for Finnish exporters, will reduce trade barriers in the future.

“In that sense, Avant’s timing in Brazil is really good,” says Matti.

There are big cultural differences between Brazil and Finland, so experience of working in the country is very important, as are language skills. Without speaking Brazilian Portuguese, it would be very difficult to work in the country – using English only is not an option.

“It is great to have Jere on the Avant team. The management and upbringing of the company will be in good hands,” says Matti, who will be retiring in the near future.

Following the example from USA

Avant’s US sales company celebrated its 10th anniversary this spring (see story on pages 18–19). Avant’s presence in North America has significantly changed the local market, with many users who had sworn by the name of skid steer machines eventually becoming Avant fans.

“Brazil looks to the US as a model in many respects. What’s good enough for the States is good enough for the Brazilian people. The US experience helps us a lot. Bureaucracy is difficult, but we can overcome it. And of course, Avant will do the same thing in Brazil that we did in the US. And maybe double it!” says Jere, laughing. ●



Photo from Avant’s Agrishow stand. Our Brazilian sales company is based in São José dos Campos, São Paulo state. São Paulo alone is home to 44 million people. “The general mood of Brazilians is very positive, nice, open and receptive,” says Jere Pitkänen.

On track at Superbloom

In the heart of London, UK, a modified Avant 860i helped transform the Tower of London moat into the beautiful Superbloom spectacle which celebrated the Platinum Jubilee of Her Majesty Queen Elizabeth II last summer.

"The 860i performed very well on the site where large volumes of soil were pushed around"

Mark Gregory, Landform



Operator Edvinas Vaitekūnas was impressed by the customized Avant. "It has more power, about five times more grip than with tyres, great traction, and is easy to manoeuvre around the site."

The most significant UK landscaping project since the London Olympics, the spectacular Superbloom totally transformed the centuries old moat at the Tower of London for her Her Majesty the Queen's Platinum Jubilee last summer. A custom-made Avant 860i loader helped to carry out the project.

Designed by Surrey-based multi-award-winning and industry-wide renowned landscape contractors Landform, the Superbloom project turned the moat into a field of flowers with the planting of over 20 million seeds of 29 different varieties. It also created a new wildlife habitat in the heart of London.

Landform's Managing Director *Mark Gregory* says the new Avant 860i was an invaluable workhorse on the Tower of London site where it was fully utilised since October last year. "We had four Avant machines in the fleet. They are so versatile and easy to move from site to site. The customised 860i performed fantastically well."

Replacing wheels with tracks

Modifications to the Avant 860i, which took several months to complete, included swapping its wheels for tracks, a conversion that was undertaken by *Andy Cox* at Moorend Limited in Gloucestershire who has over 30 years experience in tracked systems; his original four-track technology was specifically designed for ecologically sensitive surfaces.

The four-track system improves the Avant 860i's pushing power and gives it more grip, especially in wet conditions where conventional wheels can become bogged down. As each track always remains on the ground, it also offers the operator more comfort, better manoeuvrability, versatility, as well as improved stability.

"We already had an Avant 860 with wheels, but we knew we would need something a little different for the Superbloom contract. Putting tracks on the new 860i made it perfect for the project, especially as much of the work was carried out in the wet winter months," says Mark Gregory.

The machine was delivered with tailor-made attachments, too. The blade was designed locally, according to Mark's requirements. "It performed very well on the site where large volumes of soil were pushed around; we put about a thousand loads of material into the moat, about 10,000 tonnes of designed and manufactured topsoil and manufactured subsoil," says Gregory. "The blade was well up for the task."

Operator *Edvinas Vaitekūnas* was also impressed by the Avant. "It has more power, about five times more grip than with tyres, great traction and is easy to manoeuvre around



the site, plus it comes with loads of attachments, making it a very versatile machine."

The biggest and strongest Avant

The 860i is the biggest loader in the Avant range. It is powered by a 57hp Kohler diesel engine, with a lifting capacity of 1900kg and a lift height of 3.5 metres. With several different cab options, this 860i features the L variant. A low noise level combined with excellent visibility and ergonomics guarantee a comfortable working environment. Easily operated, with well-positioned controls and safe and easy access to the driver's seat, the machine working on the Superbloom project utilised several different attachments.

The 860i completed its work at the Tower of London moat at the end of April. "We use the Avant machines on a wide range of projects," says Gregory. "They do exactly what they have been designed for. They are reliable and versatile which is why they are our preferred work tools."

Landform also have two 745's, among the largest and most powerful in the 700 Series range, offering the highest lifting capacity, pulling force and drive speed, with high-flow auxiliary hydraulics that runs all Avant attachments, and telescopic boom as standard.

Like the tracked Avant 860i and wheeled 860i, the 745's are used for general landscaping and yard duties, with a variety of Avant attachments for ground care applications and construction tasks. ●



Photo: Historic Royal Palaces

“We cannot imagine our work without our green friend”

Based in Tarnów in Southern Poland, Artmon Ogrody designs and builds gardens from scratch and modernizes existing ones. After the company acquired an Avant loader, work became much easier, lighter and more pleasant. “Avant has definitely accelerated and streamlined our work. We can accept more orders in one gardening season,” says Kasia Mondel-Kmiotek.



Kasia Mondel-Kmiotek and Maciej Kmiotek, the owners of the landscape architecture company Artmon Ogrody, describe themselves as true gardening enthusiasts.

“Exceptional, unique gardens are our passion,” Kasia Mondel-Kmiotek says.

As a landscape architect, Kasia is responsible for all drafts and detailed concepts of the gardens, whereas Maciej supervises the work and puts in the hard work to make all the dashing plans a reality.

Since 2021, Maciej has been an Avant operator, but the purchase decision had been made 3 years earlier, at a gardening fair in Poznań.

“I had read about the machine, but seeing it live at the fair made a decisive impression on us. We got a fine introduction to the loader model and attachments that would serve our garden work best.”

In 2021, Artmon Orgody finally bought an Avant 635 with some gardening attachments – a rotary hoe, a pallet fork HD, a 4-in-1 bucket, a leveller, and a grabbing tool. When choosing the right equipment for the company, Maciej and Kasia took into consideration three essential things.

“Quality, functionality and reliability. Avant has it all. Avant 635 meets our demands perfectly – it is strong enough for larger areas and hard work, and small enough for tight city gardens. The greatest advantage of the machine is its agility and multifunctionality, as well as a huge number of available attachments,” Maciej says.

Surprisingly powerful hydraulics

Artmon Orgody uses the loader mainly for heavy work which was previously done either manually or with the use of smaller machines.

“The preparation of the soil has become much easier and faster. Thanks

“Quality, functionality and reliability. Avant has it all,” says Maciej Kmiotek, who runs Artmon Ogrody together with Kasia Mondel-Kmiotek.

The main advantages of Avant 635

- Multifunctionality - A wide range of attachments.
- Stability - Hydrostatic 4x4 drive provides very good grip even in difficult conditions.
- Machine power - Inconspicuous in appearance, the machine can surprisingly carry a lot.

Answers by Artmon Ogrody.



to the attachments, we can make the necessary preparations in a few hours. The enormous power of hydraulics has surprised us positively many times, especially when we work on very heavy clay and compacted ground,” says Maciej.

Artmon Ogrody has also made good use of the pallet fork. With it, they can efficiently transport materials weighing up to a ton, e.g. pallets with grass from a roll. They also use the grabbing tool extensively.

“It is very useful for planting larger specimens of plants. Our backs can finally get a breather from the drudgery,” Maciej muses.

More orders and happier customers

The Avant 635 has become Kasia’s and Maciej’s best friend for several reasons. Kasia explains that they often work around newly built houses. The sites they develop are uneven and full of construction debris and require proper preparation, cleaning and levelling. Thanks to Avant, their work has become much easier, lighter and more pleasant.

“Avant has definitely accelerated and streamlined our work. We easily carry out work that previously constituted a huge physical effort for us, meaning we save time but also our health. The loader has shortened the work time for each order, which gives us the opportunity to accept more orders

in one gardening season. Undoubtedly this also translates into the satisfaction of our customers,” says Kasia.

Kasia and Maciej love what they do, and now, as the most ungrateful tasks have become effortless, they can concentrate on developing their company. After one year with Avant 635 they are planning to acquire new attachments and expand the range of services.

“We both agree that Avant 635 is our best friend, and we simply cannot even imagine our work without it.” ●

Artmon Ogrody

1. A landscape architecture company based in Tarnów, Southern Poland.
2. The company designs and builds gardens from scratch and modernizes existing ones.
3. They also plan and install automatic irrigation systems and lighting systems in the garden and offer comprehensive implementation services.

Keeping Boston beautiful

Avant has become the preferred piece of equipment for the City of Boston. Property maintenance is now much faster. "The machine most definitely meets our needs," says Bill Coughlin, Director of Central Fleet Management.

"It's just a well-designed machine," *Daniel Ross*, General Tree Maintenance Foreman, says about the fleet of Avant machines the City of Boston purchased last year.

The City of Boston has 930 parks covering roughly 17% of all the city's area. And according to The Trust for Public Land's Parkscore, all residents are within a 10-minute walk of a park. With ninety-five Boston bike trails covering 557 miles, it is not hard to imagine the manpower, speed and efficiency the City of Boston's Park Department requires to maintain these areas.



Since purchasing their fleet of Avant equipment, the entire team has discovered how much faster they are able to get their property maintenance jobs done with these compact-but-mighty machines.

Prior to the introduction of Avant, the department used skid steers, but they were larger and harder to articulate on the many winding paths and corners found in many parks.

Perfect for bike paths

With thirty-three years working with City of Boston, and forty-seven years in the business, *Bill Coughlin*, Director of Central Fleet Management at the City of Boston, knew exactly what he was looking for in a new machine.

“We (The City of Boston) had been looking for a versatile machine for the clearing and cleaning of the bike paths. The footprint of the machine was our main concern,” Coughlin explained. “I had been looking around and the Avant appeared to be the machine we needed. We demoed a unit and then purchased a few.”

Now every city department except for EMS, Fire, and Police have an Avant unit at work for them.

“The machine most definitely meets our needs. We use it for the bike lanes here, but the Parks department uses it in the City Parks and will be looking at additional attachments this spring,” Coughlin says, noting that the City of Boston has already found many uses for the attachments they have already acquired.

Cleaning, clearing & moving materials

The Maintenance Division at the City of Boston has two Avant 760s. Operations Manager *Nate Hinchliffe* says that they have been put to good work, including cleaning maintenance yards, clearing snow from small lots and bike paths, moving trailers, and moving pallets of material. The size of an Avant makes it easy to navigate the garage bay while cleaning and moving pallets, allowing the team to do the work in-house without depending on contractors.

“It’s very durable and very comfortable, as far as even operating the machine. The way it’s small, it gets in tight areas, and the turn radius on the piece of equipment is phenomenal,” says Daniel Ross. “It’s just a really unique piece of equipment as far as getting the job done.” ●



“The Avant gets in tight areas, and the turn radius on the piece of equipment is phenomenal”, says Daniel Ross, General Tree Maintenance Foreman.

Avant loaders are routinely used for property maintenance work at Boston Common, the oldest city park in the United States.

Efficient work at French camp sites

When Camping Paradis La Brise de Camargue replaced their tractor with an Avant loader, the versatility and ease of use charmed the staff. At another camping site, Camping Tohapi Clos Cottet, a rental machine has saved costs and time.



Situated on the southern coast of France, Camping Paradis La Brise de Camargue lies in the heart of the beautiful Regional Natural Park of Camargue. Before having been introduced to Avant loaders, the camping site used a small tractor with attachments like lawn mower, flail mower and hedge cutter.

“We used it in the spring before the customers started to arrive. The equipment was getting old, and it had to be repaired more and more frequently. We also have a backhoe loader for larger scale jobs, but it is too big for certain tasks and only some of our employees know how to use it,” explains *Jean-Pierre Ticchi*, Technical Manager at Camping La Brise.

To replace the tractor with a new one, Ticchi contacted a local dealer. They suggested an Avant loader instead.

“According to them, an Avant would be much more versatile in our jobs. We then selected the Avant



635 with various attachments like the 4-in-1 bucket, pallet fork, hedge cutter, ball hitch and flail mower.”

“Today, all our employees work with the Avant because it is so easy to use. The settings and adjustments are less complicated compared to our old equipment. Everybody likes the fast changing of the attachments. We use our Avant almost every day of the year,” Ticchi says.

Cutting hedges & filling trenches

In France, campsite pitches are relatively narrow to optimize the use of space. Hedges are important for preserving privacy. Campsites spend a considerable amount of money in cutting and planting hedges.

“We cut the hedges twice a year from three directions, which amounts to 15 km of cutting. After that we drive along the hedges with the Avant flail mower to crush the shearings and make it easier for the lawn mower to collect it – without the risk of damaging the mower. We save a lot of time since we don’t collect the waste by hand anymore.”

The Avant 635 is also used for making new pitches. In the construction of a new area for large ecological tents, the staff has excavated trenches for electric cables and water pipes.

“We fill up and level the trenches with Avant. In the past, this finishing job was always made by hand because the backhoe loader was too heavy, not precise enough, and too big for the size of the pitches. It was a time-consuming and tiring job. Today, we are much more relaxed as we use the Avant. It is a compact but powerful machine,” Ticchi says.

Setting up mobile homes

Mobile homes are very popular in France. This style of accommodation makes it possible to combine the feeling of camping and the comfort level of living in a cabin.

“Moving and setting up mobile homes used to be complicated. Now, we take away the old mobile homes and set up new ones with Avant by towing them with a ball hitch mounted on the attachment coupling plate. Setting up can be done very precisely thanks to Avant’s articulated frame and telescopic boom.”

Easy and safe material handling

Ticchi regularly receives miscellaneous materials on pallets including groceries and various products for maintenance use.

“We used manual pallet trucks in the past. It was complicated with heavy loads, especially on uneven surfaces. Sometimes we took the backhoe loader, but it took 30 minutes to detach the bucket and mount the pallet fork. Today, we unload almost everything with the Avant because changing the attachment is very fast and easy.” ●

“Avant is an indispensable tool in our trade”



Located on the west coast of France, Camping Tohapi Clos Cottet is surrounded by greenery and lies just a few minutes from the beaches.

“I discovered Avant products in 2019,” says Manager *François Legrand*.

At that time, the tight budget did not allow for the purchase of a machine, so Legrand rented one. Since then, Camping Tohapi Clos Cottet has rented an Avant for some weeks every year for construction jobs and green area maintenance.

“We use several attachments like the 4-in-1 bucket, pallet fork, collecting broom, flail mower and the stump grinder. Our rental costs have reduced considerably because this single machine replaces several other machines.”

Fast operation

Occasionally, the camping site opts for the Avant 800 series, but the dimensions of the Avant 600 series is best for driving between the mobile homes.

“Avant saves our time. The removal of a 200-metre-long old fence covered with blackberry bush and ivy on concrete posts could take a whole day and three people’s work – but with Avant, two people finished the job effortlessly in just two hours!” Legrand says.

With Avant, Camping Tohapi Clos Cottet has taken considerable steps forward from manual work.

“We are considering purchasing an Avant together with another campsite nearby. The versatile machine makes hard manual work considerably easier. The Avant is an indispensable tool in our trade, it saves time and protects our employees from physical injuries,” Legrand concludes. ●



Adding a kick to landscaping in Australia



Ghostwood Landscapes – a landscaping company in New South Wales, Australia – originally acquired an Avant 423 for specific tasks only, but now the loader is doing more than three times as much work as planned. “Avant is the most versatile machine we have come across. We can’t imagine going back to our old ways of working,” says Director Blake Motycka.

Blake Motycka’s partnership with Avant began when his arborist friend gave lavish praise for the Avant mini loader he used in his own business. Motycka’s landscape contracting business, Ghostwood Landscapes in the southern highlands of New South Wales, soon began to investigate if the capabilities and performance of the small loader would suit also their needs.

Ghostwood Landscapes performs a wide range of landscaping work: vegetation management, moving landscape materials on construction sites, digging new garden beds, spreading compost and mulch, lifting and planting large trees, moving tools and lifting heavy concrete piles. The machine chosen by the company would be used for a wide range of tasks, and it would have to be easily accessible and manoeuvrable on site.

Motycka visited the local Avant dealer to test some loaders. He praises Avant Equipment manager *Steve Gage*, who gave a comprehensive explanation of the technical details of the mini loader and highlighted the benefits it could bring to the landscape contractor’s business.

“The service at Avant Equipment was nothing short of fantastic. The presentation of the loader was comprehensive, and all our questions were answered.”

After about a month of research and careful calculations, Motycka was convinced that the Avant 423 was a perfect fit for the company’s business development needs.

“The compact loader is the most versatile machine we have come across. You can do much more with it than with an



excavator, for example. It's small enough for tight spaces and doesn't damage customers' lawns. The telescopic boom is one of our favourite features."

A leap in productivity – and comfort

The Avant 423 mini loader has sparked a productivity leap for Ghostwood Landscapes.

"We can do things much faster than before. We don't have to worry about getting stuck with excess or heavy materials because we can easily move them, and we no longer have to worry about whether the rental company has the machine we need available on the days we need it," says Motycka.

After a break-in and learning phase, Ghostwood Landscapes has found plenty of new ways to use the 423.

"The jobs that we purchased the loader for now only account for about 30 percent of the work that we do with the Avant. We can't imagine going back to our old ways of working. What's more, the mini loader is so easy to use that our new apprentice started working with it in his first week."

According to Motycka, the Avant loader also has occupational health benefits.

"Landscaping is very physical. The Avant loader makes our work easier in many ways and helps us avoid strain injuries."

The Avant attachments acquired by the company have significantly reduced manual labor and replaced wheelbarrows, for instance.

Top 5 features of Avant

Answers by Ghostwood Landscapes.

1. "Telescopic boom. For loading into high sided trucks and mulch in garden beds."
2. "Gentle under foot. Leaves clients' lawns intact without damage."
3. "Boom float. Makes it easy to spread and level compost, soil, gravel etc."
4. "Quick coupling connection. Makes it quick and easy to change attachments onsite."
5. "Ability to purchase extra attachments in the future. One machine with so many uses."

Great service and expedient deliveries have also played their part in Ghostwood Landscapes' productivity leap.

"When we call or email Avant Equipment, no question is too challenging. And the last time we ordered an attachment, it was delivered the same day!" Motycka reveals.

Appetite comes with eating. Motycka plans to expand the range of Avant attachments even further.

"For example, a digger and a spring tine cultivator would be useful." ●



"The compact Avant loader is the most versatile machine we have come across."

Blake Motycka, Ghostwood Landscapes

AVANT

AVANT TECNO PRESENTS

MORE AVANT

THE NEW 645i x 650i MODELS

www.avanttecho.com